

PLANTA ESTRUTURAL
E= 1/100

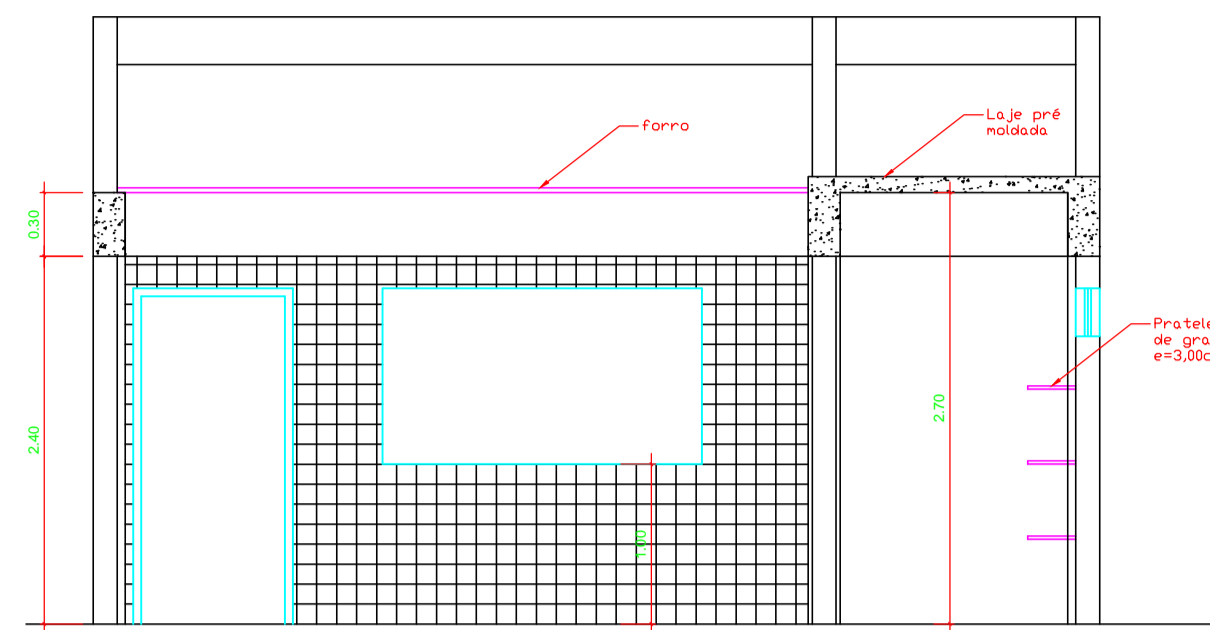

CORTE AA
E= 1/100

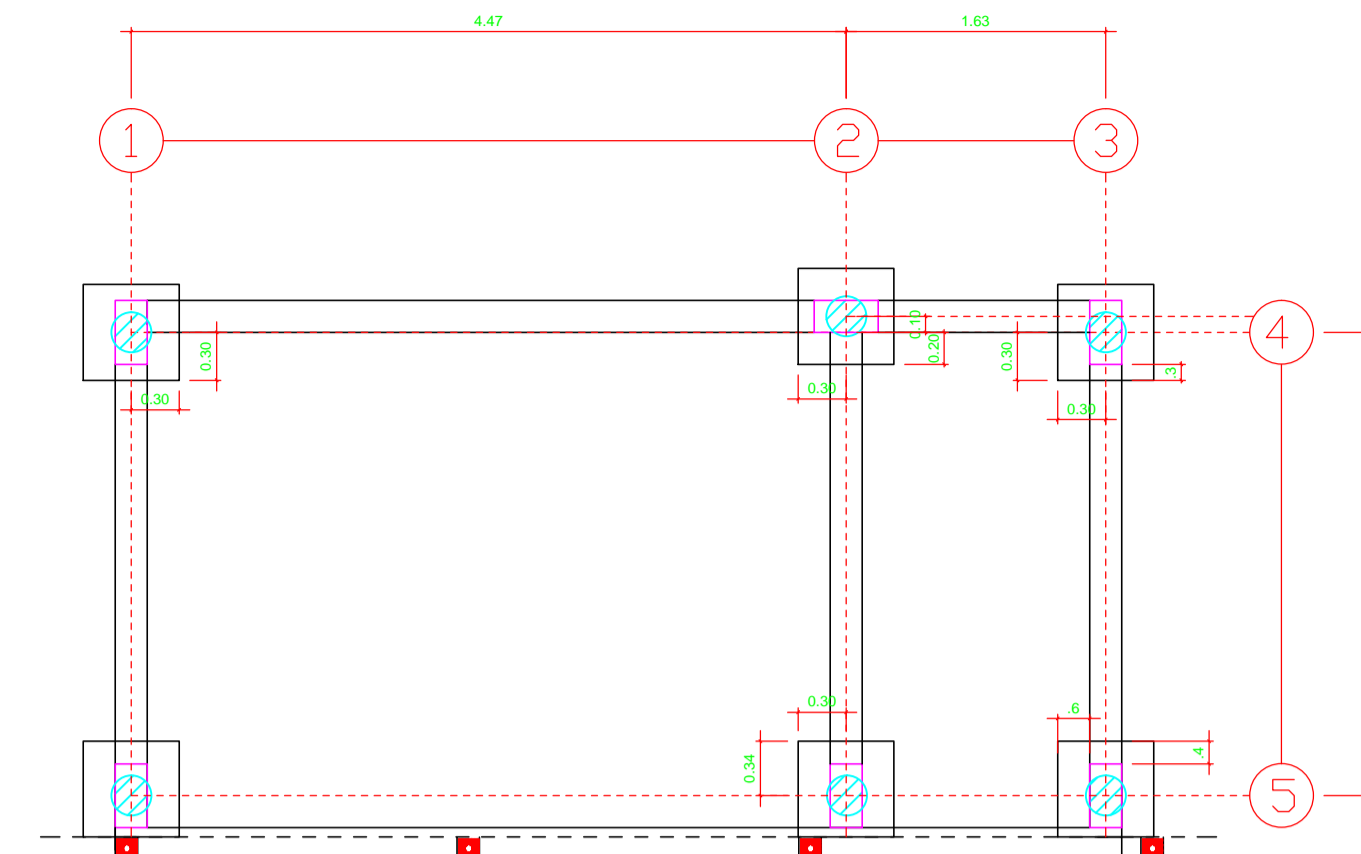

VISTA LATERAL (OU
VISTA DE FRENTE)
E= 1/100

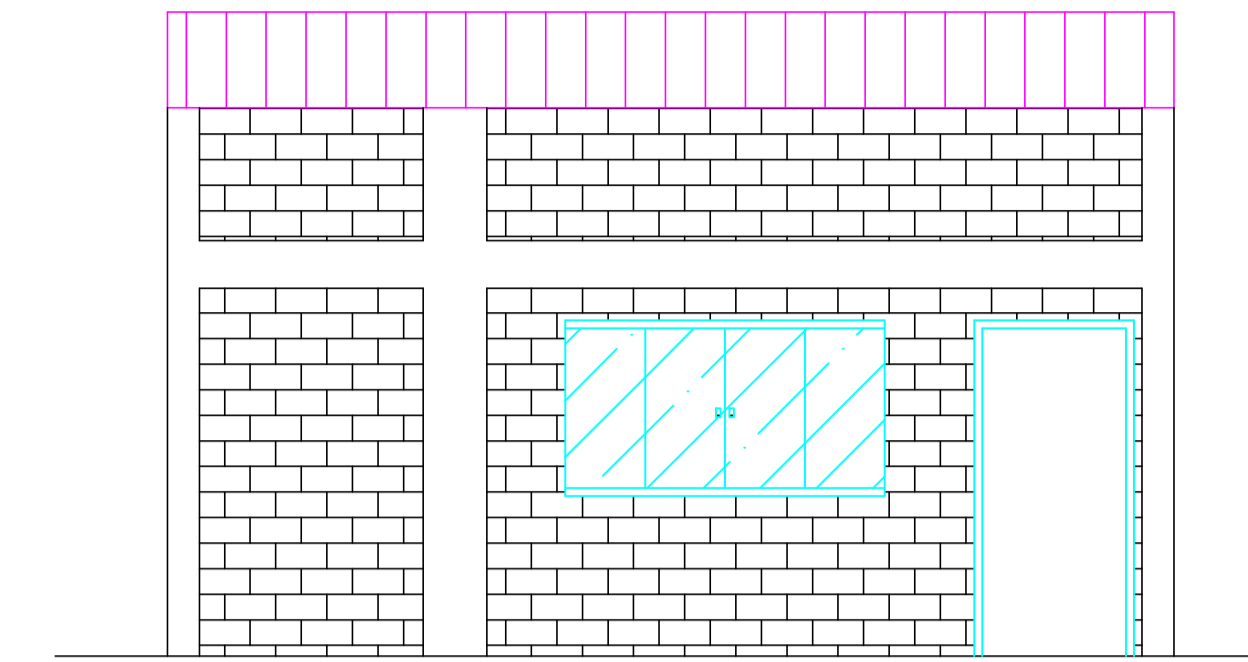

FACHADA
E= 1/100

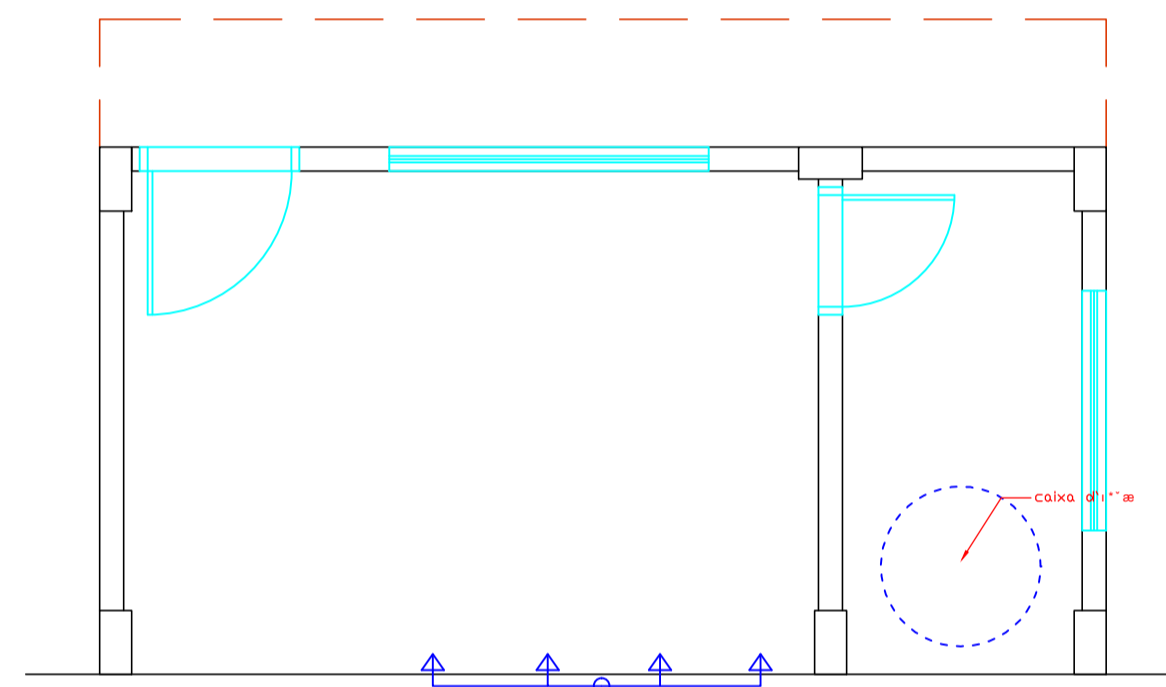

PLANTA BAIXA
E= 1/100

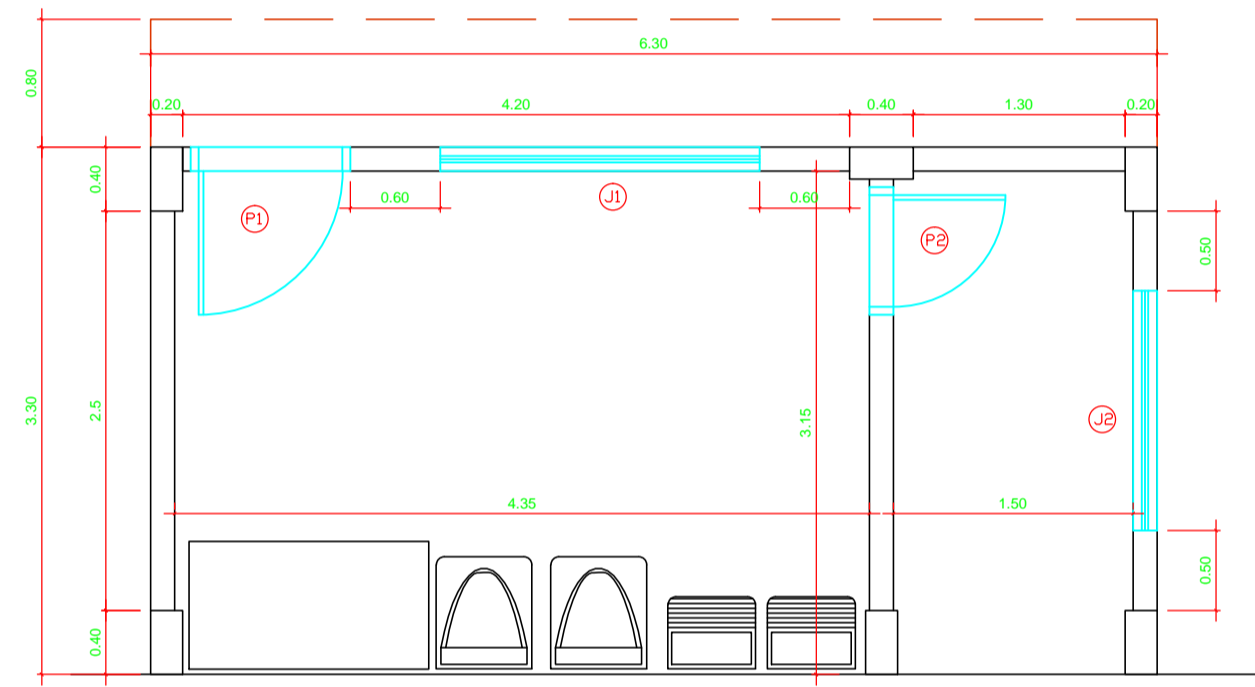

PLANTA BAIXA
E= 1/100

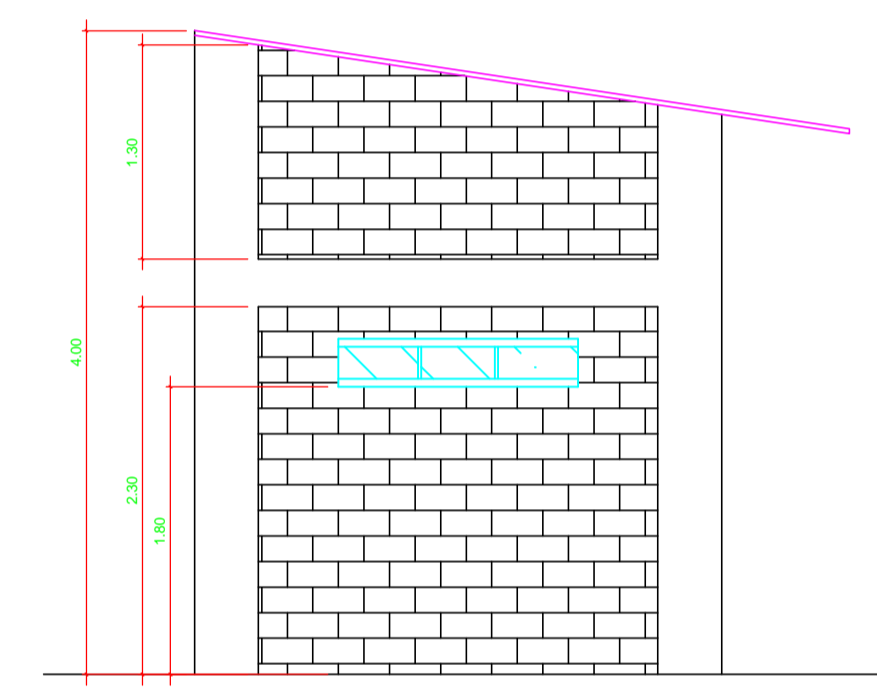

VISTA LATERAL
E= 1/100

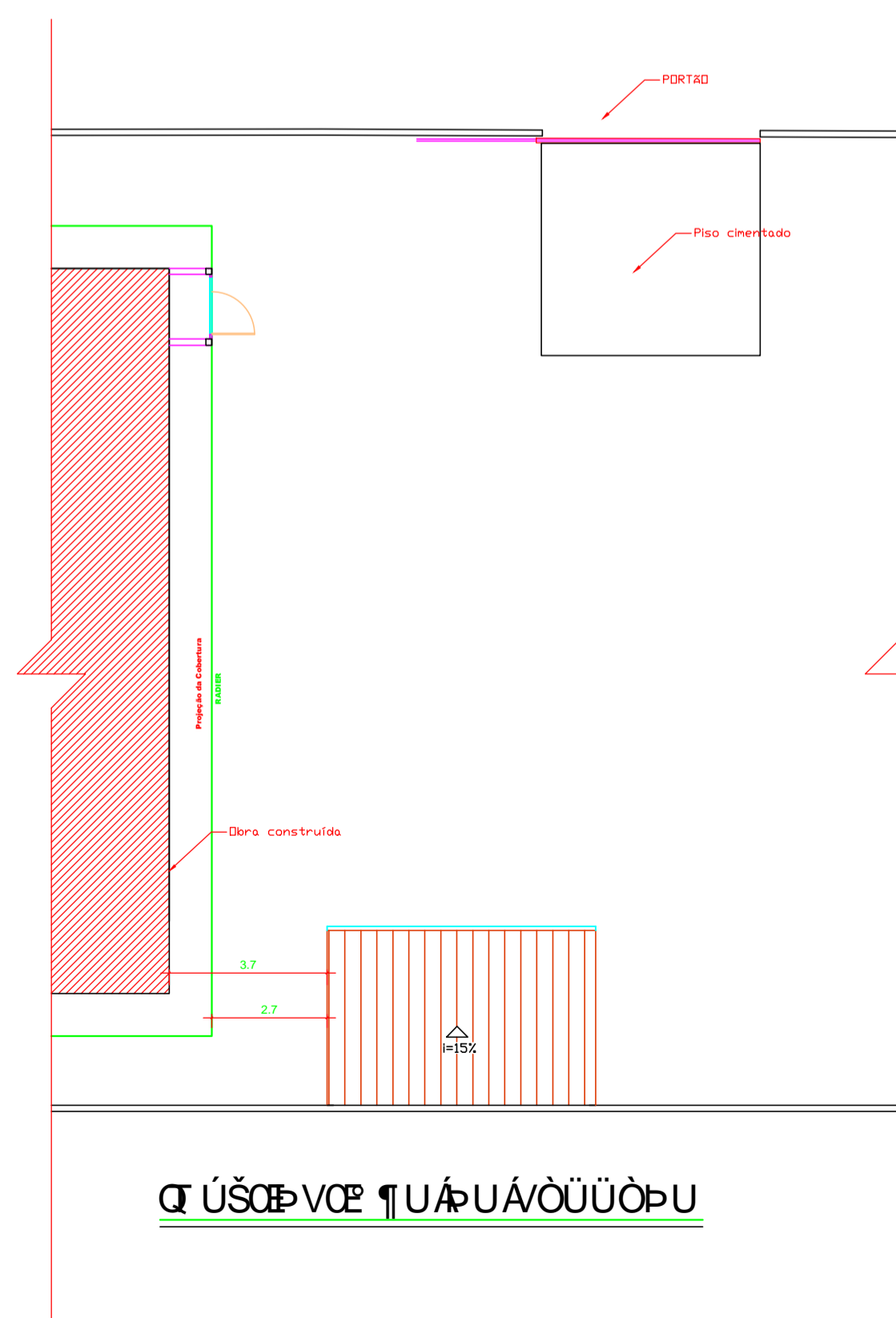
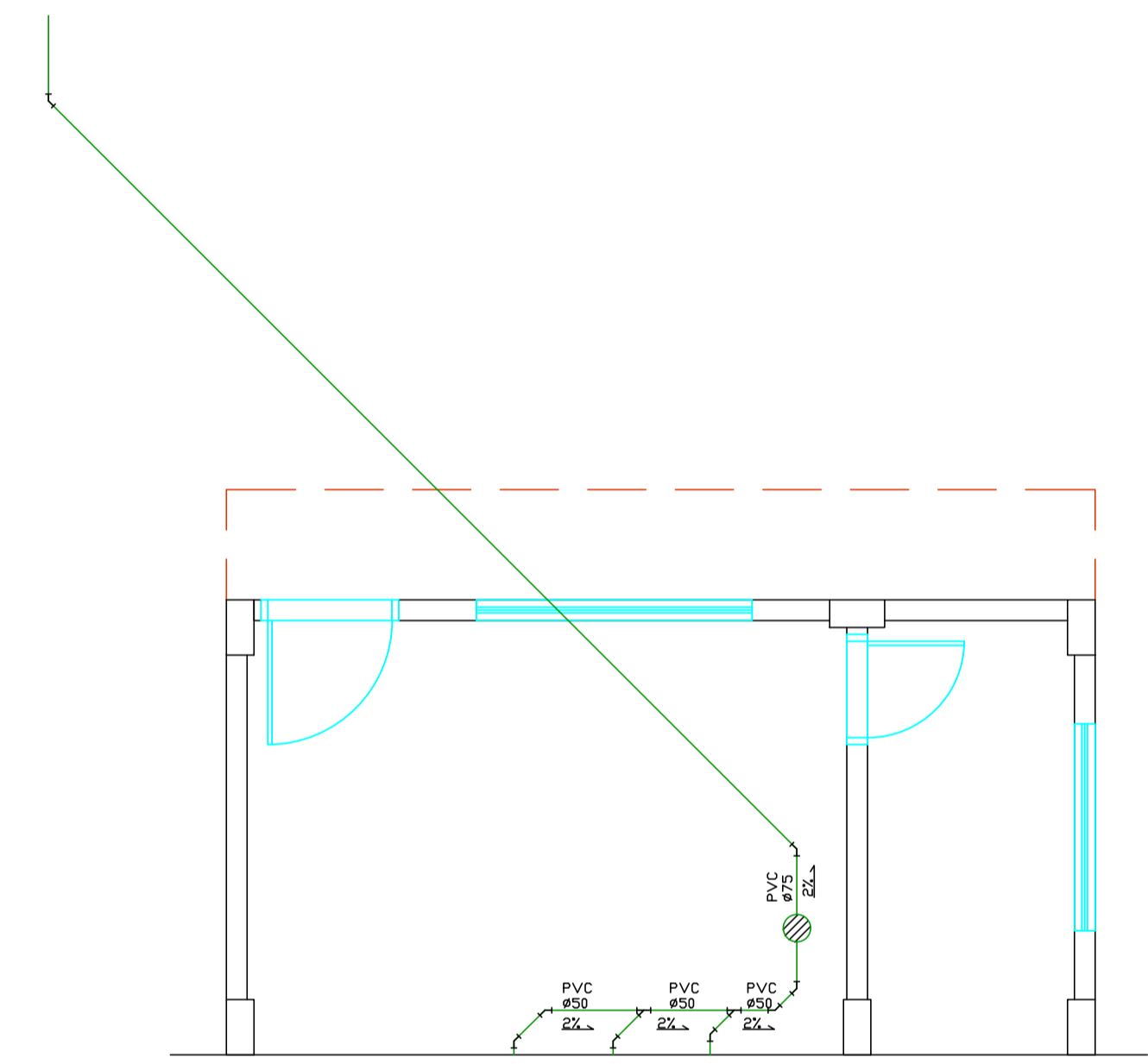

DETALHE- PORTÃO
E= 1/100

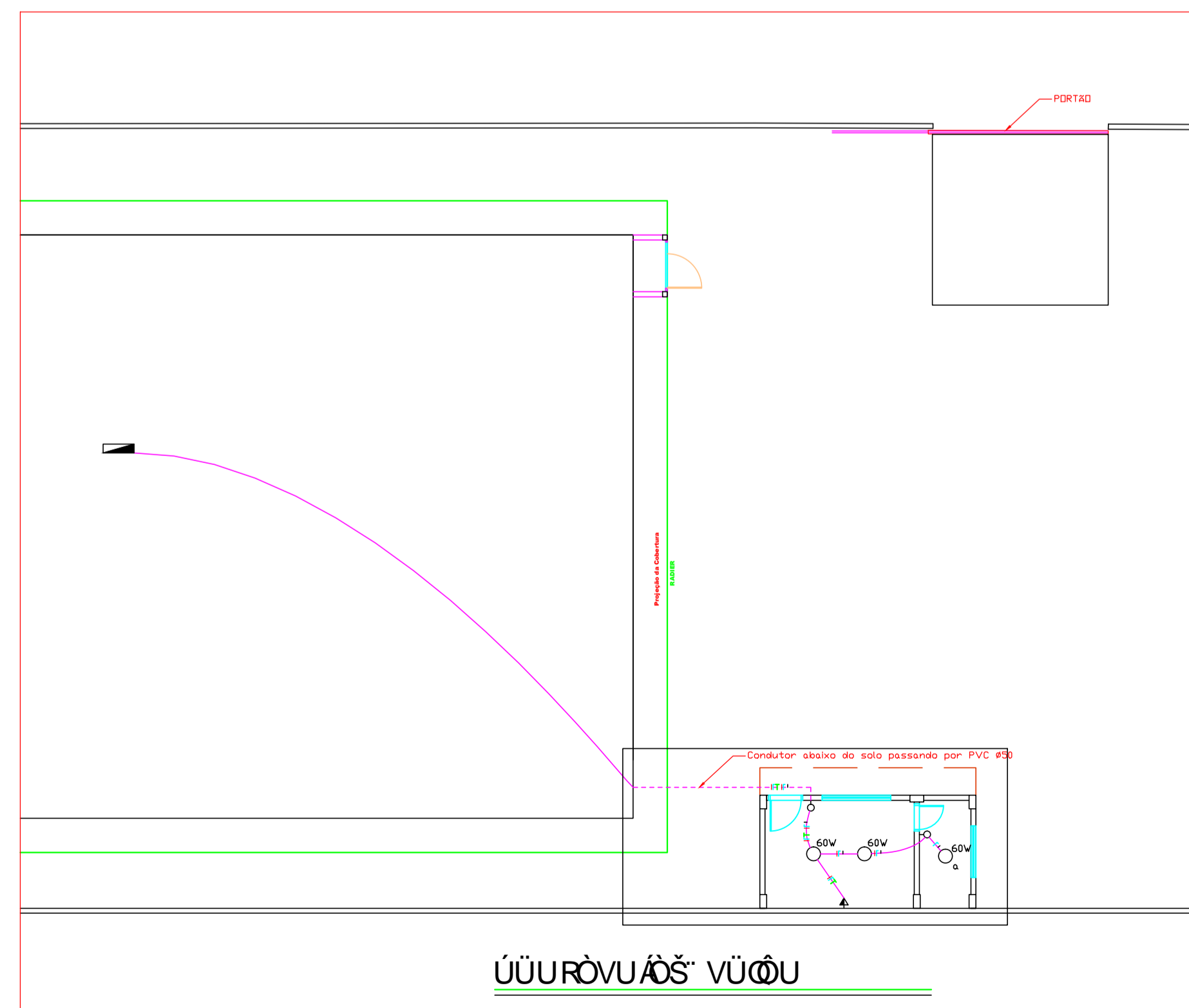

DETALHE- PORTÃO
E= 1/100

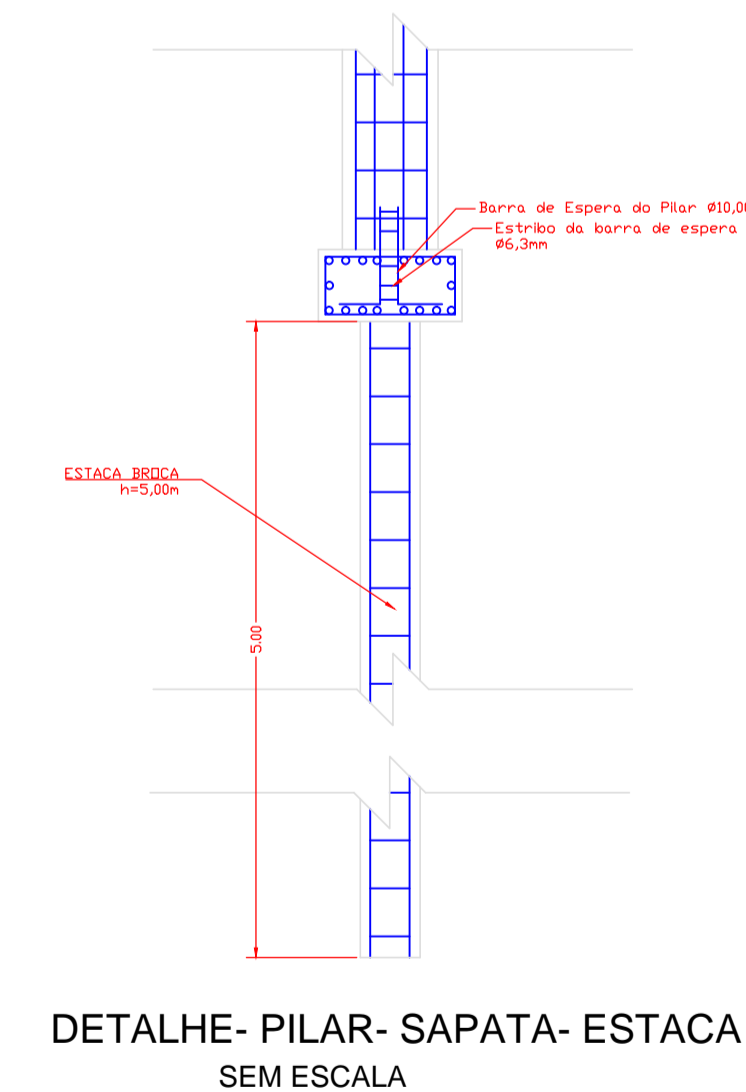

DETALHE- PILAR- SAPATA- ESTACA
SEM ESCALA

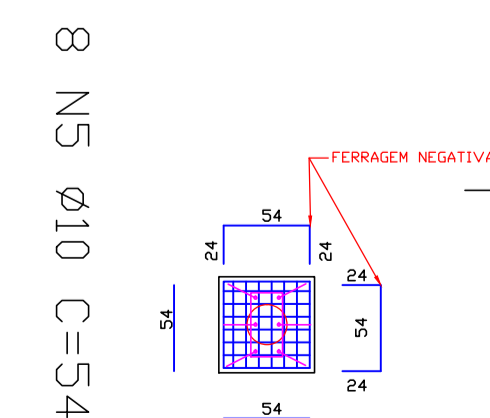

8 N5 Ø10 C=54

DETALHE- SAPATAS
SEM ESCALA

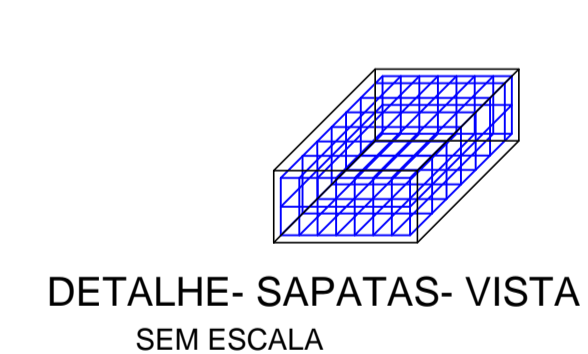

DETALHE- SAPATAS- VISTA
SEM ESCALA

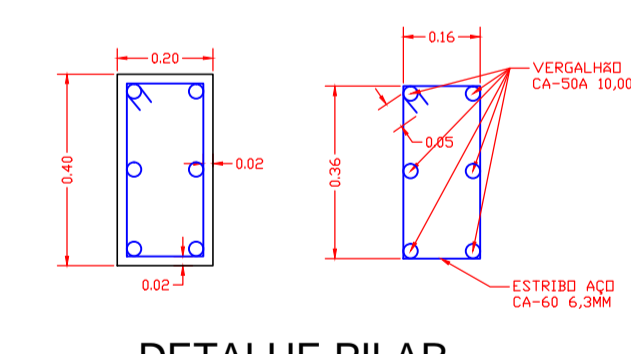

DETALHE PILAR
SEM ESCALA

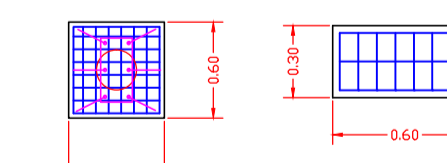

DETALHE- SAPATAS- VISTA SUPERIOR E LATERAL
SEM ESCALA

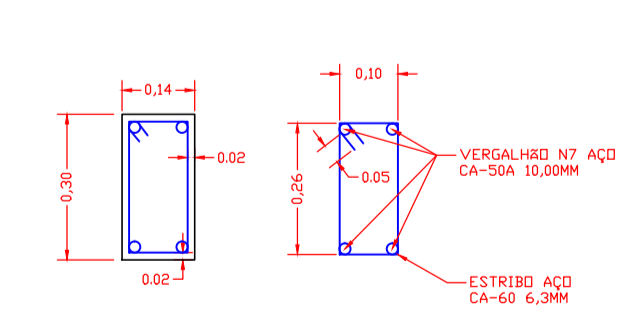

DETALHE- VIGA
SEM ESCALA

PROJETO LAVANDERIA		
PROJETO: CRECHE NO BAIRRO DO ITAIM, CAMBUI-MG		
PROFISSIONAL: GREGORY WELLS DE CARVALHO BARTELES CREA- PR 172329-D		
DATA	Escala	Folha Nº
24/06/2020	1:100	01/01